

**Patented Product**

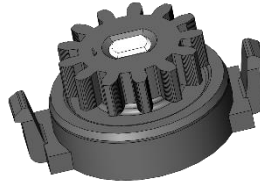

This damper is used in many applications - storage bins, sunglass holders, overhead bins, ashtrays, covers, and any other light to medium sliding or rotary applications.

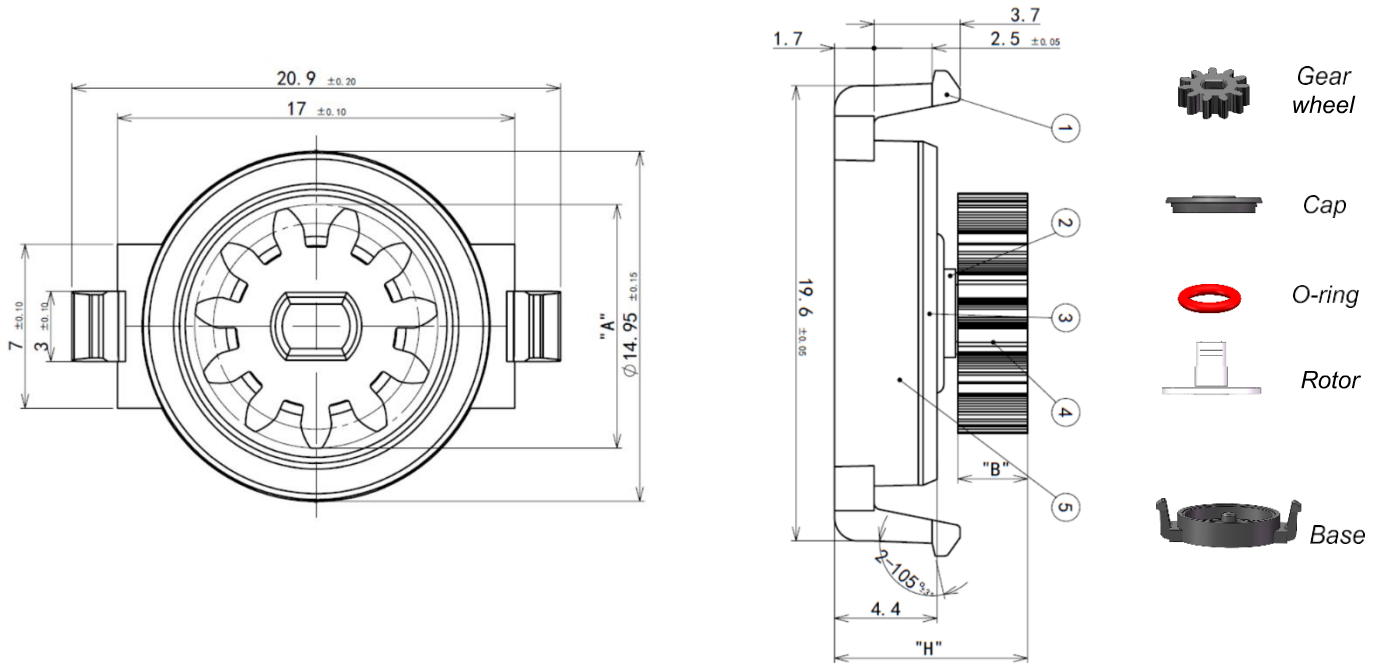

<b>Gear Wheels</b>	01	02	03	04	05	06				
<b>Pressure angle [Deg]</b>	20°	20°	14,5°	20°						
<b>Module</b>	0,8									
<b>N. Teeth</b>	11	16	13	11	16	10				
<b>Outside circle Ø [mm] "A"</b>	10,4	14	12	10,4	14,4	9,6				
<b>Gear Height [mm] "B"</b>	3	4,5	3	4,5	3	3,6				
<b>Total Height [mm] "H"</b>	8.3±0.40	9.8±0.50	8.3±0.40	9.8±0.50	8.3±0.40	8.6±0.50				



## Suggested Housing

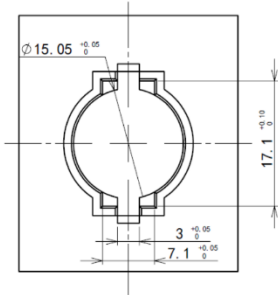

## Sample Application

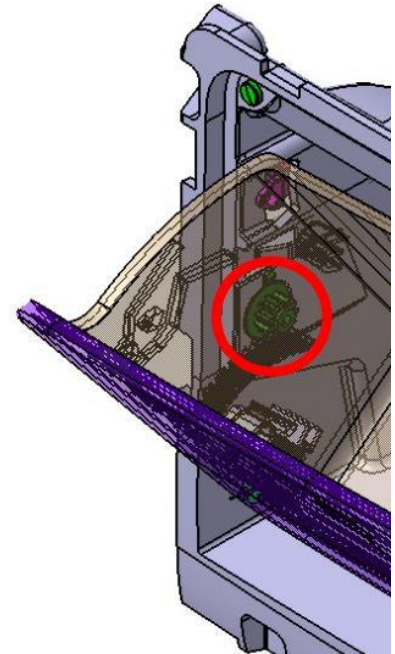

## Mountings to avoid

**Axial load**

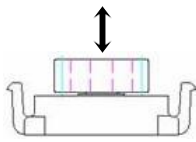

**Angular**

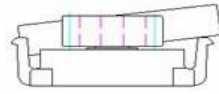

**Radial load**

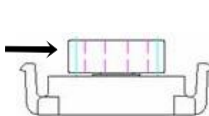

**Misalignment**

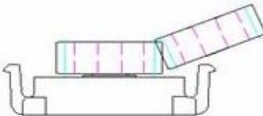

## Working Conditions

<b>Temperature</b>	-40°C up to +90°C
<b>Lifetime</b>	100.000 cycles at 20 rpm and RT (1 cycle = 0°+360°+0°)

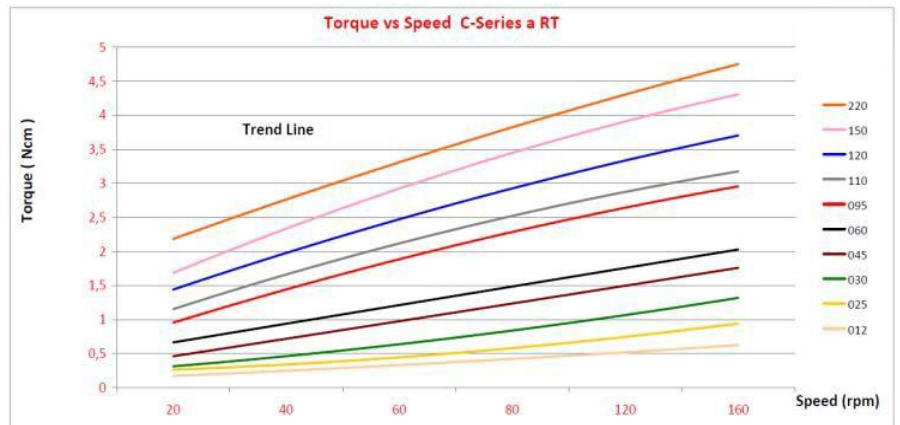

## Bill Of Materials

<b>Gear</b>	POM
<b>Rotor</b>	POM
<b>Base</b>	PC
<b>Cap</b>	PC
<b>O-Ring</b>	Silicone
	Silicone oil

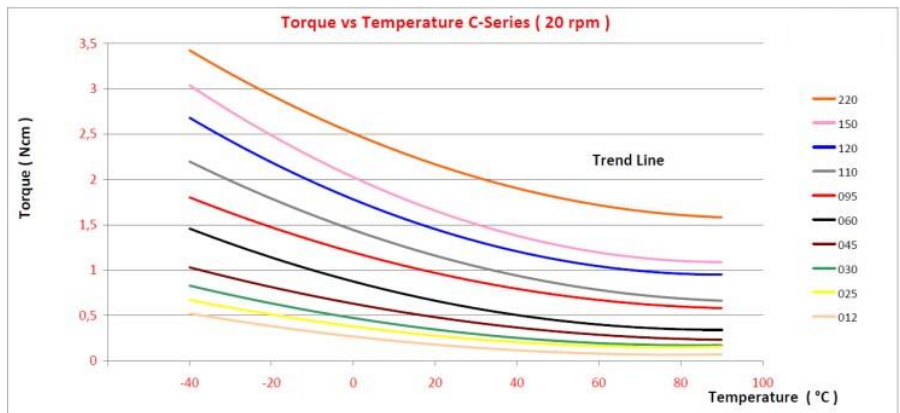

## Product Key

Type
D01:Classic (free rotating)











Fixing
007:holes thin body

**D01007**

**01**

**045**

Gear Wheel
01: 11 teeth – lower ISO- module 0,8 – 3 mm height
02: 16 teeth - module 0,8-4,5 mm height
03: 13 teeth - module 0,8 – 3 mm height – 14,5° pressure angle
04: 11 teeth - module 0,8-4,5 mm height
05: 16 teeth - module 0,8 – 3 mm height
06: 10 teeth - module 0,8 – 3,5 mm height

Torque [Ncm] (•)	Colour
025 = 0,25 Ncm ± 0,08 at 20 rpm and RT (•)	
030 = 0,30 Ncm ± 0,10 at 20rpm and RT (•)	
045 = 0,45 Ncm ± 0,12 at 20rpm and RT (•)	
060 = 0,60 Ncm ± 0,17 at 20 rpm and RT (••)	
060 = 0,80 Ncm ± 0,15 at 20 rpm and RT (••)	
095 = 0,95 Ncm ± 0,18 at 20 rpm and RT (•••)	
110 = 1,10 Ncm ± 0,20 at 20 rpm and RT (•••)	
120 = 1,20 Ncm ± 0,20 at 20 rpm and RT (•••)	
150 = 1,50 Ncm ± 0,25 at 20 rpm and RT (•••)	
220 = 2,20 Ncm ± 0,35 at 20 rpm and RT (•••)	

(•) = Torque 100% checked in production at 160 rpm and RT  
 (••) = Torque 100% checked in production at 120 rpm and RT  
 (•••) = Torque 100% checked in production at 80 rpm and RT

The official 2D drawing is the only valid technical documentation.

All the characteristics and dimensions written into this datasheet may in fact change and so will not be valid anymore.

All products are 100% tested on the torque value.

Bases, gear, wheels, torques and colors can be combined, having a design flexibility.

Custom designs are also available

